



## Main

Range of product	OsiSense XU
Series name	Application assembly Application material handling
Electronic sensor type	Photo-electric sensor
Sensor name	XUK
Sensor design	Compact 50 x 50
Detection system	Diffuse distance sensor
Material	Plastic
Type of output signal	Analogue + discrete
Wiring technique	5-wire
Discrete output type	PNP or NPN
Discrete output function	1 NO or 1 NC programmable
Analogue output range	0...10 V
Electrical connection	1 male connector M12, 5 pins
Product specific application	Distance measurement on object
Emission	Red laser diffuse distance sensor class 1 IEC 60825-1
[Sn] nominal sensing distance	16.40 Ft (5 m) diffuse distance sensor

## Complementary

Enclosure material	ABS/PC
Lens material	PMMA
Maximum sensing distance	16.40 Ft (5 m) diffuse distance sensor
Output type	Analog Solid state
Add on input	External teach
Status LED	1 LED yellow)output state 1 LED green/yellow)supply on/output state
[Us] rated supply voltage	24 V DC reverse polarity protection
Supply voltage limits	18...30 V DC
Switching capacity in mA	<= 100 mA overload and short-circuit protection)
Switching frequency	<= 500 Hz
Maximum voltage drop	<2 V
Current consumption	<= 60 mA no-load
Maximum delay first up	300 Ms
Maximum delay response	1.2 Ms
Maximum delay recovery	1.2 Ms
Setting-up	Using teach button or remote teaching
Depth	1.97 In (50 mm)

Height	1.97 In (50 mm)
Width	0.91 In (23 mm)
Net weight	0.08 Lb(US) (0.035 kg)



## Environment

Product certifications	CE CULus Ecolab
Ambient air temperature for operation	-4...122 °F (-20...50 °C), UL -40...140 °F (-40...60 °C)
Ambient air temperature for storage	-40...176 °F (-40...80 °C)
Vibration resistance	7 gn +/- 1.5 mm 10...55 Hz) IEC 60068-2-6
Shock resistance	30 gn 11 ms) IEC 60068-2-27
IP degree of protection	IP67 IEC 60529 IP69K conforming to DIN 40050

## Packing Units

Unit Type of Package 1	PCE
Number of Units in Package 1	1
Package 1 Weight	1.98 Oz (56 g)
Package 1 Height	1.10 In (2.8 cm)
Package 1 width	3.54 In (9 cm)
Package 1 Length	2.36 In (6 cm)
Package 2 Weight	4.07 Lb(US) (1.848 kg)

## Offer Sustainability

EU RoHS Directive	Pro-active compliance (Product out of EU RoHS legal scope)  <a href="#">EU RoHS Declaration</a>
Mercury free	Yes
RoHS exemption information	 Yes

## Contractual warranty

Warranty	18 months
----------	-----------

## Dimensions

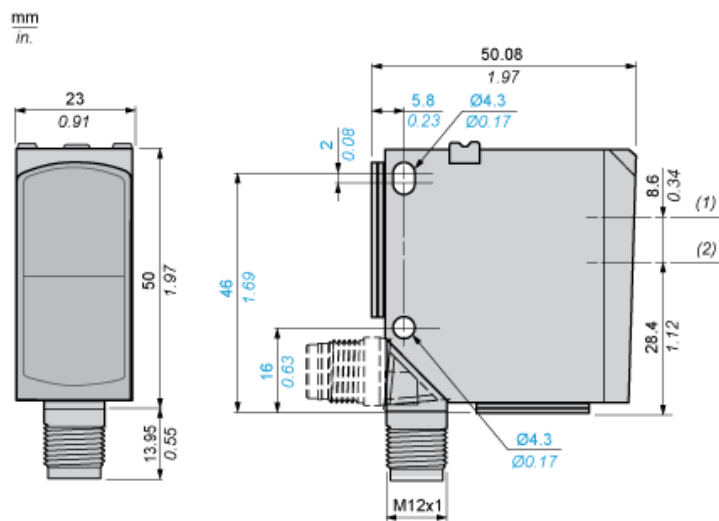

- (1) Transmitter optical axis
- (2) Receiver optical axis

## Connections and Schema

### Connector Wiring

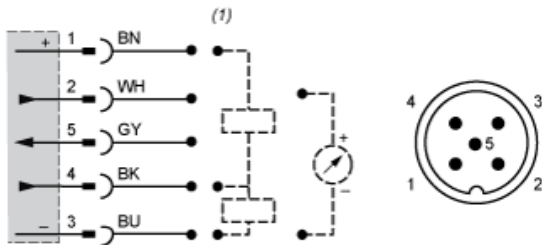

- (1) Auto-detect  
1: + UB (BN: Brown)  
2: QA (WH: White)  
3: -UB (BU: Blue)  
4: Q (BK: Black)  
5: IN (GY: Grey)

Curves

Size of light spot (typical)

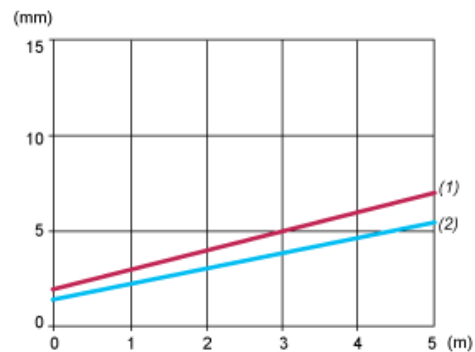

- (1) Vertical (y)
- (2) Horizontal (x)
- 0...15 Size :
- 0...5 Distance

Curves

Output characteristic curve

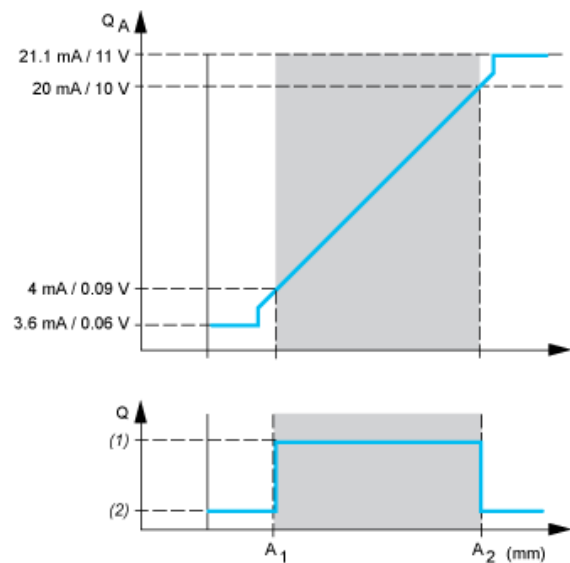

- $Q_A$  : Analogue output
- $Q$  : Switching output
- (1) High
- (2) Low

---

Mounting

---

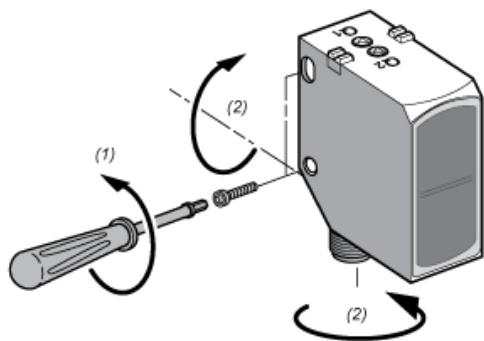

- (1) < 1,5 Nm (13 lb-in)
- (2) < 1 Nm (8.85 lb-in)

Product Life Status :	Commercialised
-----------------------	----------------