

I/O module - AXL F DI16/1 DO16/1 2H - 2702106

Please be informed that the data shown in this PDF Document is generated from our Online Catalog. Please find the complete data in the user's documentation. Our General Terms of Use for Downloads are valid (<http://phoenixcontact.com/download>)

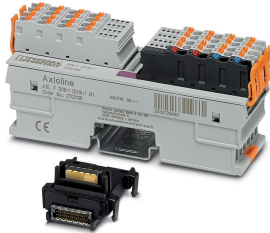

Axioline F, Digital I/O module, Digital inputs: 16, 24 V DC, connection method: 1-conductor, Digital outputs: 16, 24 V DC, 500 mA, connection method: 1-conductor, transmission speed in the local bus: 100 Mbps, degree of protection: IP20, including bus base module and Axioline F connectors

Product Description

The module is designed for use within an Axioline F station.
It is used to acquire and output digital signals.
The filter times of the inputs can be adjusted to increase noise immunity.
Filter times of 100 μ s enable the user to implement a counting function with a maximum input frequency of 5 kHz in the application.
The outputs are protected against short circuit and overload.

Your advantages

- ✓ 16 digital inputs according to EN 61131-2 type 1 and type 3
- ✓ 24 V DC, 2.4 mA
- ✓ Connection of sensors in 1-conductor technology
- ✓ Filter times can be adjusted in three increments: < 100 μ s, 1000 μ s or 3000 μ s
- ✓ Maximum input frequency: 5 kHz
- ✓ 16 digital outputs
- ✓ 24 V DC, 500 mA
- ✓ Connection of actuators in 1-conductor technology
- ✓ Minimum update time of < 100 μ s
- ✓ Device rating plate stored



Key Commercial Data

Packing unit	1 pc
GTIN	 4 046356 960441
GTIN	4046356960441
Weight per Piece (excluding packing)	220.000 g
Custom tariff number	85389091

I/O module - AXL F DI16/1 DO16/1 2H - 2702106

Country of origin	Germany
-------------------	---------

Technical data

Dimensions

Width	35 mm
Height	129.9 mm
Depth	54 mm
Note on dimensions	The depth is valid when a TH 35-7,5 DIN rail is used (according to EN 60715).

Ambient conditions

Ambient temperature (operation)	-25 °C ... 60 °C
Ambient temperature (storage/transport)	-40 °C ... 85 °C
Permissible humidity (operation)	5 % ... 95 % (non-condensing)
Permissible humidity (storage/transport)	5 % ... 95 % (non-condensing)
Air pressure (operation)	70 kPa ... 106 kPa (up to 3000 m above sea level)
Air pressure (storage/transport)	70 kPa ... 106 kPa (up to 3000 m above sea level)
Degree of protection	IP20

Connection data

Designation	Axioline F connector
Connection method	Push-in connection
Note on the connection method	Please observe the information provided on conductor cross sections in the "Axioline F: system and installation" user manual.
	Applications with UL approval: only use copper conductors.
Conductor cross section solid min.	0.2 mm ²
Conductor cross section solid max.	1.5 mm ²
Conductor cross section flexible min.	0.2 mm ²
Conductor cross section flexible max.	1.5 mm ²
Conductor cross section AWG min.	24
Conductor cross section AWG max.	16
Stripping length	8 mm

General

Mounting type	DIN rail
Color	traffic grey A RAL 7042
Net weight	210 g
Note on weight specifications	with connectors and bus base module
Mounting position	any (no temperature derating)

Interfaces

Designation	Axioline F local bus
-------------	----------------------

I/O module - AXL F DI16/1 DO16/1 2H - 2702106

Technical data

Interfaces

Number	2
Connection method	Bus base module
Transmission speed	100 Mbps

Axioline potentials

Designation	Axioline F local bus supply (U_{Bus})
Supply voltage	5 V DC (via bus base module)
Current consumption	max. 120 mA (up to HW 01)
	max. 60 mA (as of HW 02)
Power consumption	max. 600 mW (up to HW 01)
	max. 300 mW (as of HW 02)
Designation	Supply for digital input and output modules (U_{IO})
Supply voltage	24 V DC
Supply voltage range	19.2 V DC ... 30 V DC (including all tolerances, including ripple)
Current consumption	max. 8 A (provide external protection)
Power consumption	max. 240 W (of which 1.25 W internal losses)
Protective circuit	Surge protection electronic (35 V, 0.5 s)
	Reverse polarity protection parallel diode; with external 5 A fuse (only for commissioning)
Protection	max. 8 A (polarity reversal protection up to 5 A)

Digital inputs

Input name	Digital inputs
Description of the input	EN 61131-2 types 1 and 3
Connection method	Push-in connection
Connection technology	1-conductor
Number of inputs	16
Protective circuit	Polarity reversal protection of the inputs parallel diode (30 V, 5 s)
Nominal input voltage U_{IN}	24 V DC
Nominal input current at U_{IN}	2.4 mA
Input filter time	3000 μ s (Default)
	1000 μ s
	< 100 μ s
Input voltage range "0" signal	-3 V DC ... 5 V DC
Input voltage range "1" signal	11 V DC ... 30 V DC

Digital outputs

Output name	Digital outputs
Connection method	Push-in connection

I/O module - AXL F DI16/1 DO16/1 2H - 2702106

Technical data

Digital outputs

Connection technology	1-conductor
Number of outputs	16
Protective circuit	Short-circuit protection, overload protection of the outputs electronic
Output voltage	24 V DC
Nominal output voltage	24 V DC
Nominal load, inductive	max. 12 VA (1.2 H, 48 Ω, with nominal voltage)
Nominal load, lamp	max. 12 W (at nominal voltage)
Nominal load, ohmic	max. 12 W (48 Ω, with nominal voltage)
Switching frequency	max. 10000 per second (with at least 50 mA load current)
Load min.	10 kΩ
Output voltage when switched off	max. 1 V
Output current when switched off	max. 300 μA
Behavior with overload	Shutdown with automatic restart
Behavior with inductive overload	Output can be destroyed
Reverse voltage resistance to short pulses	limited protection up to 0.5 A for 1 s

Electrical isolation

Test section	5 V supply of the local bus (U_{Bus}) / 24 V supply (I/Os) 500 V AC 50 Hz 1 min.
	5 V supply of the local bus (U_{Bus}) / functional ground 500 V AC 50 Hz 1 min.
	24 V supply (I/O)/functional ground 500 V AC 50 Hz 1 min.

Standards and Regulations

Immunity to ESD	Noise immunity test in accordance with EN 61000-6-2 Electrostatic discharge (ESD) EN 61000-4-2/IEC 61000-4-2 Criterion B, 6 kV contact discharge, 8 kV air discharge
Immunity to EF	Noise immunity test in accordance with EN 61000-6-2 Electromagnetic fields EN 61000-4-3/IEC 61000-4-3 Criterion A, Field intensity: 10 V/m
Immunity to burst	Noise immunity test in accordance with EN 61000-6-2 Fast transients (burst) EN 61000-4-4/IEC 61000-4-4 Criterion B, 2 kV
Immunity to surge	Noise immunity test in accordance with EN 61000-6-2 Transient overvoltage (surge) EN 61000-4-5/IEC 61000-4-5 Criterion B, DC supply lines: ±0.5 kV/±0.5 kV (symmetrical/asymmetrical)
Immunity to conducted interference	Noise immunity test in accordance with EN 61000-6-2 Conducted interference EN 61000-4-6/IEC 61000-4-6 Criterion A, Test voltage 10 V
Interference emission	Noise emission test according to EN 61000-6-3 Class B
Mechanical tests	Vibration resistance in acc. with EN 60068-2-6/IEC 60068-2-6 5g
	Shock in acc. with EN 60068-2-27/IEC 60068-2-27 30g
	Continuous shock according to EN 60068-2-27/IEC 60068-2-27 10g
Protection class	III (IEC 61140, EN 61140, VDE 0140-1)

I/O module - AXL F DI16/1 DO16/1 2H - 2702106

Technical data

Environmental Product Compliance

REACH SVHC	Lead 7439-92-1
China RoHS	Environmentally Friendly Use Period = 50 years
	For details about hazardous substances go to tab "Downloads", Category "Manufacturer's declaration"

Drawings

Connection diagram

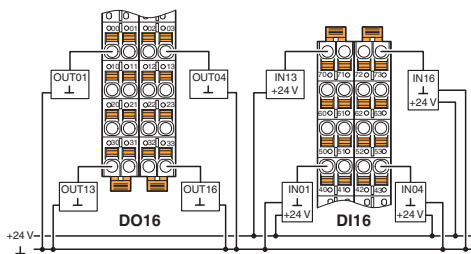

Typical connection of sensors and actuators when using external busbars

Connection diagram

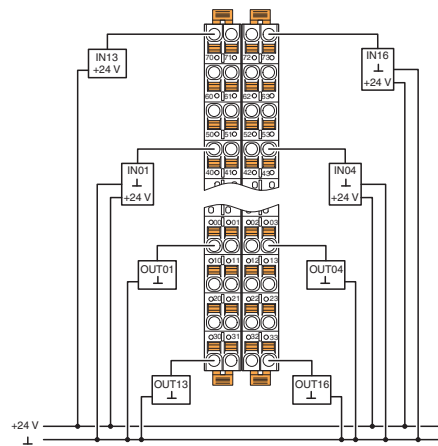

Connection in 1-conductor technology

I/O module - AXL F DI16/1 DO16/1 2H - 2702106

Block diagram

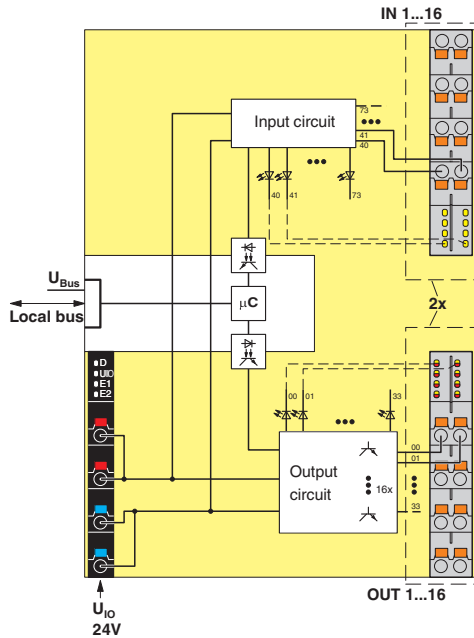

Dimensional drawing

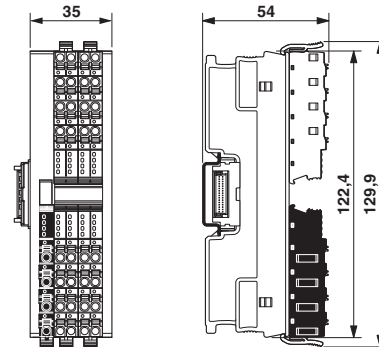

Internal wiring of the terminal points

Diagram

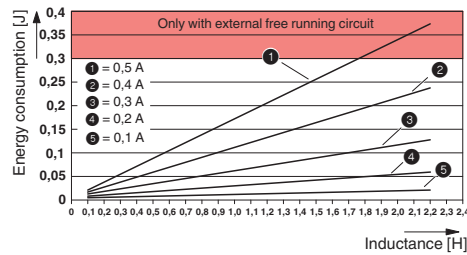

Maximum outputs power consumption when inductive loads are switched off

Classifications

eCl@ss

eCl@ss 10.0.1	27242604
eCl@ss 11.0	27242604
eCl@ss 5.1	27242600
eCl@ss 6.0	27242600
eCl@ss 7.0	27242604
eCl@ss 8.0	27242604

I/O module - AXL F DI16/1 DO16/1 2H - 2702106

Classifications

eCl@ss

eCl@ss 9.0	27242604
------------	----------

ETIM

ETIM 5.0	EC001599
ETIM 6.0	EC001599
ETIM 7.0	EC001599

UNSPSC

UNSPSC 13.2	32151602
UNSPSC 18.0	32151602
UNSPSC 19.0	32151602
UNSPSC 20.0	32151602
UNSPSC 21.0	32151602

Approvals

Approvals

Approvals

KR / NK / ABS / RINA / NK / ABS / RINA / KR / PRS / BV / LR / BSH / DNV GL / UL Listed / cUL Listed / UL Listed / cUL Listed / DNV GL

Ex Approvals

Approval details

KR		http://www.krs.co.kr/eng/main/main.aspx	HMB17372-AC002
----	--	---	----------------

NK		http://www.classnk.or.jp/hp/en/	14A006
----	--	---	--------

ABS		http://www.eagle.org/eagleExternalPortalWEB/	18-HG1767360-PDA
-----	--	---	------------------

I/O module - AXL F DI16/1 DO16/1 2H - 2702106

Approvals

RINA		http://www.rina.org/en	ELE030120XG
NK	ClassNK	http://www.classnk.or.jp/hp/en/	14A006
ABS		http://www.eagle.org/eagleExternalPortalWEB/	18-HG1767360-PDA
RINA		http://www.rina.org/en	ELE030120XG
KR		http://www.krs.co.kr/eng/main/main.aspx	HMB17372-AC002
PRS		http://www.prs.pl/	TE/2239/880590/19
BV		http://www.veristar.com/portal/veristarinfo/generalinfo/approved/approvedProducts/equipmentAndMaterials	36433/B1 BV
LR		http://www.lr.org/en	LR2001902TA
BSH			840
DNV GL		https://approvalfinder.dnvgl.com/	TAA00000DF
UL Listed		http://database.ul.com/cgi-bin/XYV/template/LISEXT/1FRAME/index.htm	FILE E 238705

I/O module - AXL F DI16/1 DO16/1 2H - 2702106

Approvals

cUL Listed		http://database.ul.com/cgi-bin/XYV/template/LISEXT/1FRAME/index.htm	FILE E 238705
------------	--	---	---------------

UL Listed		http://database.ul.com/cgi-bin/XYV/template/LISEXT/1FRAME/index.htm	FILE E 238705
-----------	--	---	---------------

cUL Listed		http://database.ul.com/cgi-bin/XYV/template/LISEXT/1FRAME/index.htm	FILE E 238705
------------	--	---	---------------

DNV GL		https://approvalfinder.dnvgl.com/	TAA00000DF
--------	--	---	------------

Accessories

Accessories

DIN rail connector

Bus connector - AXL F BS H - 2700992



Axioline F bus base module for housing type H

System cable

Round cable - VIP-CAB-FLK14/AXIO/0,14/0,5M - 2901604



Round cable set; controller: Axioline Realtime I/O; connection 1: Single wires (8-position) (The wires are marked and fitted with ferrules); connection 2: IDC/FLK socket strip (1x 14-position, 90 °-out put); cable length: 0.5 m

I/O module - AXL F DI16/1 DO16/1 2H - 2702106

Accessories

Round cable - VIP-CAB-FLK14/AXIO/0,14/1,0M - 2901605



Round cable set; controller: Axioline Realtime I/O; connection 1: Single wires (8-position) (The wires are marked and fitted with ferrules); connection 2: IDC/FLK socket strip (1x 14-position, 90 °-out put); cable length: 1 m

Round cable - VIP-CAB-FLK14/AXIO/0,14/1,5M - 2901606



Round cable set; controller: Axioline Realtime I/O; connection 1: Single wires (8-position) (The wires are marked and fitted with ferrules); connection 2: IDC/FLK socket strip (1x 14-position, 90 °-out put); cable length: 1.5 m

Round cable - VIP-CAB-FLK14/AXIO/0,14/2,0M - 2901607



Round cable set; controller: Axioline Realtime I/O; connection 1: Single wires (8-position) (The wires are marked and fitted with ferrules); connection 2: IDC/FLK socket strip (1x 14-position, 90 °-out put); cable length: 2 m

Round cable - VIP-CAB-FLK14/AXIO/0,14/2,5M - 2901608



Round cable set; controller: Axioline Realtime I/O; connection 1: Single wires (8-position) (The wires are marked and fitted with ferrules); connection 2: IDC/FLK socket strip (1x 14-position, 90 °-out put); cable length: 2.5 m

Round cable - VIP-CAB-FLK14/AXIO/0,14/3,0M - 2901609



Round cable set; controller: Axioline Realtime I/O; connection 1: Single wires (8-position) (The wires are marked and fitted with ferrules); connection 2: IDC/FLK socket strip (1x 14-position, 90 °-out put); cable length: 3 m

I/O module - AXL F DI16/1 DO16/1 2H - 2702106

Accessories

Round cable - VIP-CAB-FLK14/AXIO/0,14/4,0M - 2901610



Round cable set; controller: Axioline Realtime I/O; connection 1: Single wires (8-position) (The wires are marked and fitted with ferrules); connection 2: IDC/FLK socket strip (1x 14-position, 90 °-out put); cable length: 4 m

Round cable - VIP-CAB-FLK14/AXIO/0,14/6,0M - 2901611



Round cable set; controller: Axioline Realtime I/O; connection 1: Single wires (8-position) (The wires are marked and fitted with ferrules); connection 2: IDC/FLK socket strip (1x 14-position, 90 °-out put); cable length: 6 m

Terminal marking

Zack marker strip - ZB 20,3 AXL UNPRINTED - 0829579



Zack marker strip for Axioline F (device labeling), in 2 x 20.3 mm pitch, unprinted, 25-section, for individual labeling with B-STIFT 0.8, X-PEN, or CMS-P1-PLOTTER

Zack Marker strip, flat - ZBF 10/5,8 AXL UNPRINTED - 0829580



Zack Marker strip, flat, Strip, white, unlabeled, can be labeled with: PLOTMARK, CMS-P1-PLOTTER, mounting type: snap into flat marker groove, for terminal block width: 10.15 mm, lettering field size: 4 of 10.15 x 5 mm and 1 of 5.8 x 5 mm, Number of individual labels: 50